

**DESCRIPTION**

- ELECTRONIC BALLAST
- ELECTRONIC TRANSFORMER
- SWITCH MODE POWER SUPPLY

**FEATURES:**

- LOW THERMAL RESISTANCE
- HIGH INPUT RESISTANCE
- FAST SWITCHING
- ROHS COMPLIANT

**MAXIMUM RATINGS (T<sub>c</sub>=25°C)**

PARAMETER	SYMBOL	VALUE	UNIT
Drain-source Voltage	VDS	80	V
gate-source Voltage	VGS	±20	V
Continuous Drain Current	ID	290	A
Drain Current-Pulsed	IDM	900	A
Total Dissipation	PD	375	W
Junction Temperature	T <sub>j</sub>	175	°C
Storage Temperature Range	T <sub>stg</sub>	-55-175	°C
Single Pulse Avalanche Energy (L=0.5mH)	EAS	720	mJ

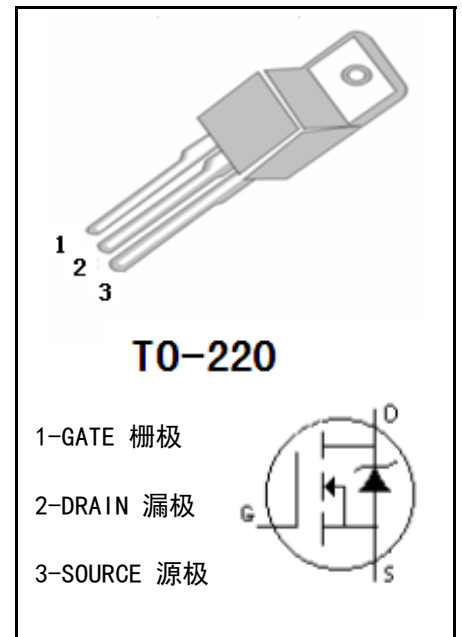
**MECHANICAL**

**ELECTRONIC CHARACTERISTICS (T<sub>c</sub>=25°C)**

CHARACTERISTICS	SYMBOL	TEST CONDITION	MIN	MAX	UNIT
Drain-source Breakdown Voltage	BVDSS	VGS=0V, ID=250 μA	80		V
Gate Threshold Voltage	VGS (TH)	VGS=VDS, ID=250 μA	2	4	V
Drain-source Leakage Current	IDSS	VDS=80V, VGS=0V		1	uA
Drain-Source Diode Forward Voltage	VSD	VGS=0V, IS=20A		1.2	V
Gate-body Leakage Current (VDS = 0)	IGSS	VGS=±20V		±100	nA
Static Drain-source On Resistance	RDS (ON)	VGS=10V, ID=20A		2.4	mΩ
Thermal Resistance Junction-case	RthJ-c			0.4	°C/W

**■ DYNAMIC CHARACTERISTICS (T<sub>c</sub>=25°C)**

CHARACTERISTICS	SYMBOL	TEST CONDITION	MIN	TYP	MAX	UNIT
Input Capacitance	C <sub>iss</sub>	V <sub>DS</sub> =35V, V <sub>GS</sub> =0V, f=1.0MHz	-	10500	-	pF
output Capacitance	C <sub>oss</sub>		-	1250	-	pF
Reverse Transfer Capacitance	C <sub>rss</sub>		-	40	-	pF
Gate resistance	R <sub>G</sub>	V <sub>DS</sub> =0V, V <sub>GS</sub> =0V, f=1.0MHz	-	0.65	-	Ω

**■ SWITCHING CHARACTERISTICS (T<sub>c</sub>=25°C)**

CHARACTERISTICS	SYMBOL	TEST CONDITION	MIN	TYP	MAX	UNIT
Turn-On Delay Time	t <sub>d(on)</sub>	V <sub>DD</sub> =40V, I <sub>D</sub> =20A, V <sub>GS</sub> =10V, R <sub>G</sub> =3Ω	-	35	-	ns
Turn-On Rise Time	t <sub>r</sub>		-	23	-	ns
Turn-Off Delay Time	t <sub>d(off)</sub>		-	70	-	ns
Turn-Off Rise Time	t <sub>f</sub>		-	13	-	ns
Total Gate Charge	Q <sub>g</sub>	V <sub>DS</sub> =40V, I <sub>D</sub> =20A, V <sub>GS</sub> =10V	-	124	-	nC
Gate-Source Charge	Q <sub>gs</sub>		-	37	-	nC
Gate-Drain Charge	Q <sub>gd</sub>		-	10	-	nC

**■ DRAIN-SOURCE DIODE MAXIMUM RATINGS AND CHARACTERISTICS (T<sub>c</sub>=25°C)**

CHARACTERISTICS	SYMBOL	TEST CONDITION	MIN	TYP	MAX	UNIT
Diode Forward Voltage	V <sub>SD</sub>	V <sub>GS</sub> =0V, I <sub>S</sub> =20A	-	-	1.2	V
Reverse Recovery Time	t <sub>rr</sub>	V <sub>R</sub> =40V, I <sub>F</sub> =20A, di/dt=400A/μs	-	77	-	ns
Reverse Recovery Charge	Q <sub>rr</sub>		-	420	-	nC

**CHARACTERISTICS CURVE**

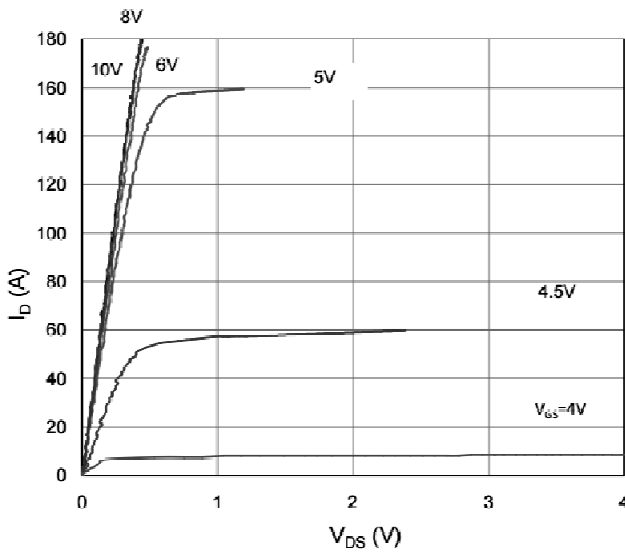

**Output Characteristic**

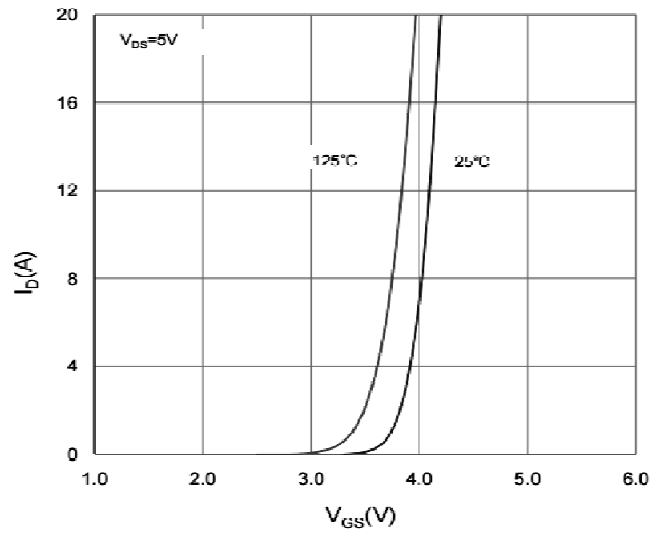

**Transfer Characteristic**

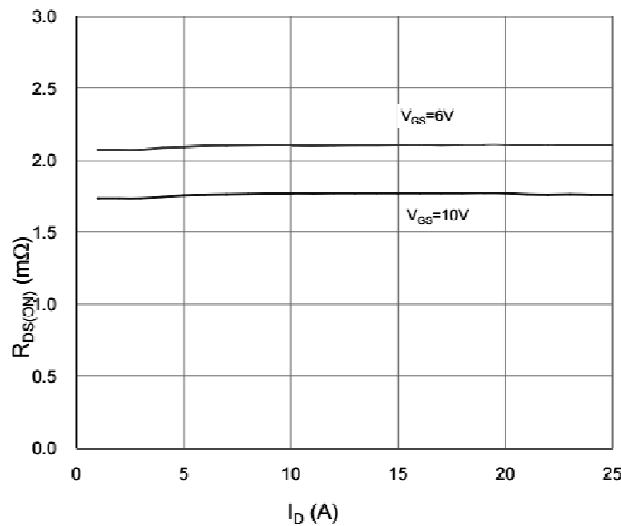

**On Resistance Vs Drain Current**

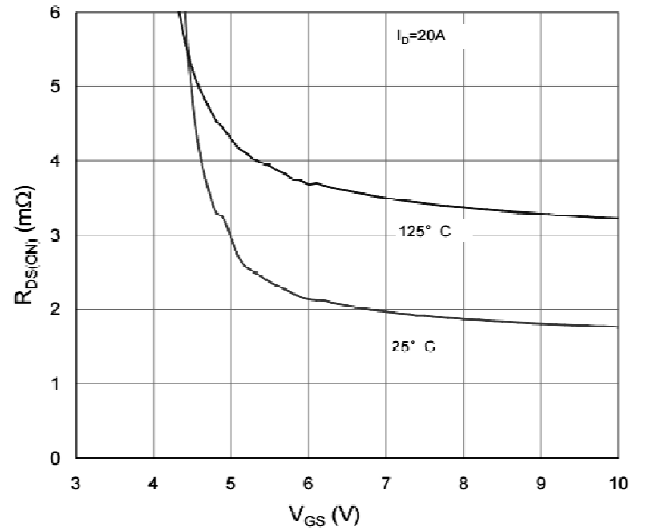

**On-Resistance vs. Gate-Source Voltage**

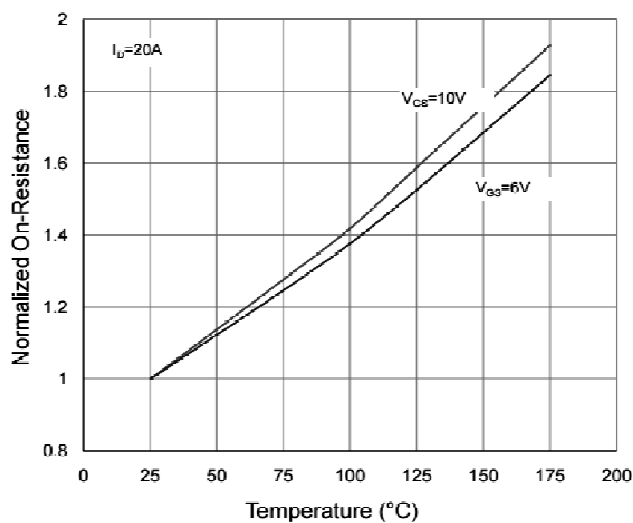

**On Resistance Vs Junction Temperature**

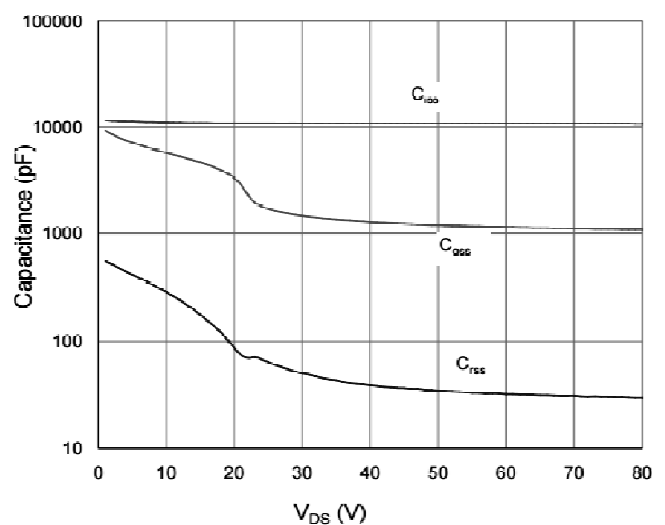

**Capacitance**

**CHARACTERISTICS CURVE**

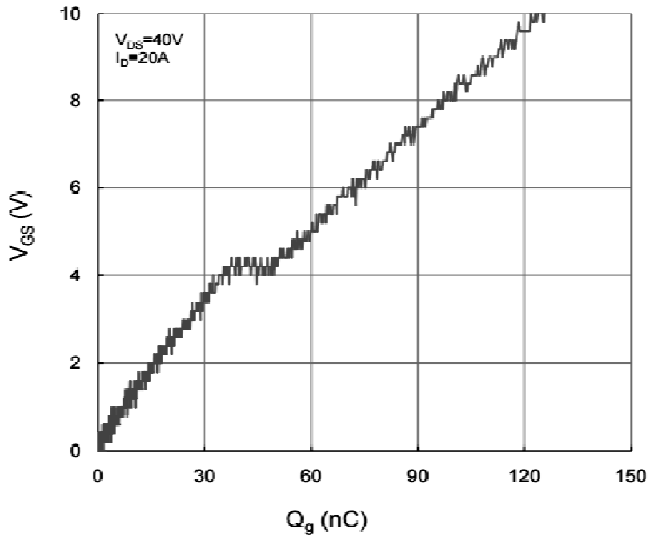

**Gate Charge Waveform**

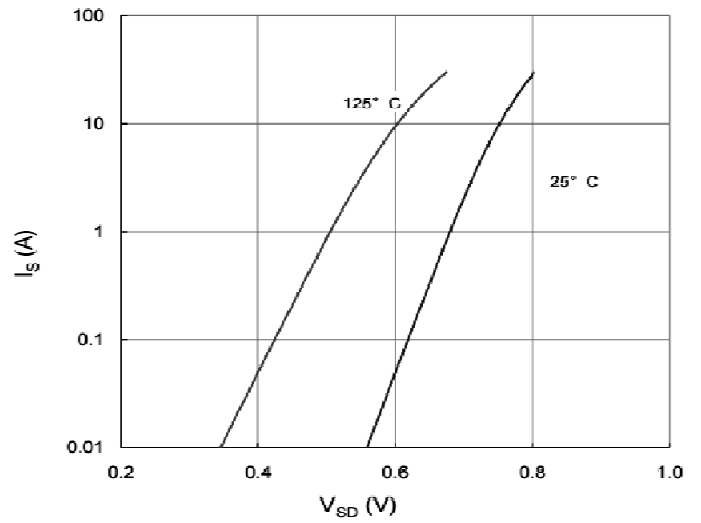

**Source-Drain Diode Forward Voltage**

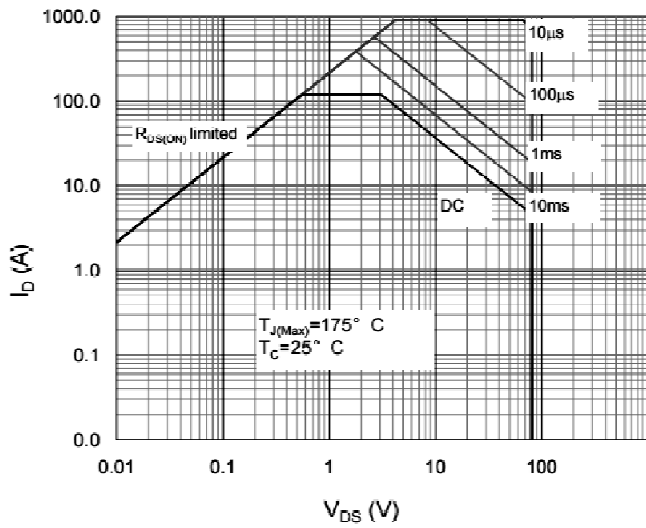

**Maximum Safe Operating Area**

**TO-220 MECHANICAL DATA**

UNIT: mm

SYMBOL	MIN	NOM	MAX	SYMBOL	MIN	NOM	MAX
A	4		4.8	e	2.44	2.54	2.64
B	1.2		1.4	F	1.1		1.4
B1	1		1.4	L	12.5		14.5
b1	0.75		0.95	L1	3	3.5	4
c	0.4		0.55	ΦP	3.7	3.8	3.9
D	15		16.5	Q	2.5		3
D1	5.9		6.9	Q1	2		2.9
E	9.9		10.7				

